



***baja designs***<sup>®</sup>  
THE SCIENTISTS OF LIGHTING

## 24-On Can Am Maverick R, OnX6+/S8 Shock Tower Kit Instructions

(44-8192, 44-8193, 44-8194, 44-8195, 44-8196)



2950 Norman Strasse San Marcos, CA 92069

Phone 760-560-2252 X3 • Fax 760-560-0383

info@bajadesigns.com • [www.bajadesigns.com](http://www.bajadesigns.com)



**baja designs**<sup>®</sup>  
THE SCIENTISTS OF LIGHTING

## LIMITED LIFETIME WARRANTY

Baja Designs proudly offers a LIFETIME WARRANTY against manufacturer's defect on all the products that we manufacture.

These are comprehensive warranties; other than the exclusions below – you're covered. If your LED or HID bulb burns out, you're covered. Additionally, cutting off our connector or changing your lenses does not automatically void your warranty.

### **Exclusions:**

Installation errors, abuse, misuse, or crash damage. You must be the original owner of the product and can supply proof of purchase.

Baja Designs manufactures its own products as well as resells products manufactured by others. Baja Designs makes no express or implied warranties on products not manufactured by Baja Designs including without limitation any warranties or merchantability and fitness for a purpose. We will, however, pass on all warranties made by the manufacturer, who has sole responsibility for performing such warranties.

Baja Designs will pay the freight if your product is less than 90 days old, otherwise defective products must be returned to Baja Designs, Inc., freight prepaid. At our option, we will repair or replace items in question and return them at no charge. If the identical product is no longer available, we will replace it with a similar product of equal value. Baja Designs Inc. will not be responsible for any indirect or consequential damages in connection with defective merchandise.

Items purchased through a Baja Designs authorized dealer must be returned through the dealer. Only available on LED auxiliary lights and product must be in sellable condition at MSRP. Product that has been damaged in any way after the original purchase date will be excluded from this guarantee.

### **Indemnification:**

**Buyer hereby acknowledges off-roading, racing and driving at night are dangerous activities and that the products and/or supplies purchased from Baja Designs are used in an inherently dangerous activity that may endanger life and limb; and in no event shall the seller, or seller's heirs and assigns, be held liable for consequential damages, nor shall seller's liability on any claim for damages arising out of or connected with the sale, delivery, or use of purchased products and/or supplies exceed the purchase price of the products and/or supplies.**

**Buyer is responsible for ensuring that it uses the products (and its vehicle) in accordance with all applicable laws, regulations, guidelines, and standards of care. Buyer acknowledges that some products may only be used when off-roading, and Buyer will comply with all vehicle and road safety guidelines. Buyer is solely responsible for (and will indemnify and hold Bestop harmless for) any claims, losses, damages, fines, fees, costs, or other amounts arising out of Buyer's non-compliance with these provisions.**

**\*\*For a color copy of instructions, visit your vehicle specific application on BajaDesigns.com \*\***

**Required Tool(s):**

- 13mm Wrench
- 13mm Deep Socket
- 7/16 Socket
- ¼" or 3/8" drive ratchet/socket wrench
- T25, T27 Bit/ Driver
- 10mm Socket

**Parts List:**

 <p><b>(Qty: 1)</b> Shock Tower Bracket</p>	 <p><b>(64-0129) (Qty: 1)</b> Wire Harness</p>	 <p><b>(64-0156) (Qty: 2)</b> Thick EPDM 1X 2.5" Strip 1X 3.5" Strip</p>	 <p><b>(20-1006) (Qty:2)</b> 8mm Nyloc Nut</p>
 <p><b>(44-9422) (Qty: 1)</b> Shock Tower Clamp</p>	 <p><b>(Qty: 1)</b> Light bar</p>	 <p><b>(20-9155) (Qty: 2)</b> M8 Spacer .75ODX1.75 Length Black</p>	 <p><b>(20-9154) (QTY: 2)</b> M8X1.25X75mm Bolt</p>
 <p><b>(20-1022) (QTY: 4)</b> 8mm Flat Washer</p>	 <p><b>(20-1278) (QTY: 1)</b> ¼-20 U Nut</p>	 <p><b>(20-1012) (QTY: 1)</b> ¼-20 X 5/8" Bolt</p>	 <p><b>(20-1282) (QTY:1)</b> ¼-20 Flat washer</p>
 <p><b>(20-1612) (QTY: 10)</b> Hardware, Zip Tie 50 Lbs 8"</p>			

To begin, make sure the vehicle is in park and on level ground.

**Step 1: Pull the driver seat forward**

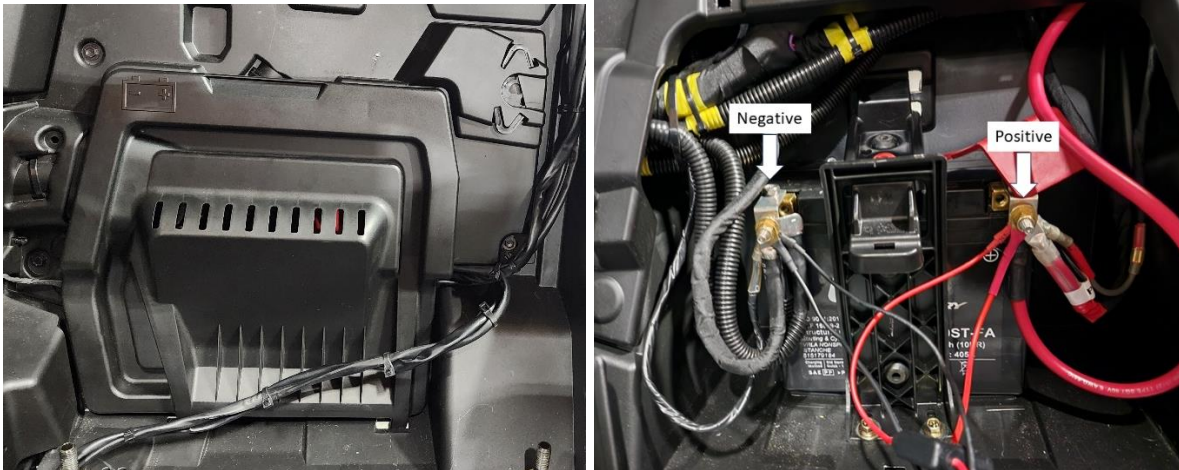

Remove the battery cover by pulling outward from the top. Using a 10mm wrench, remove the negative battery cable followed by the positive.

**Step 2: Remove Shock Cover.**

Gently pull up at the circled locations to release the clips (Clip locations circled). Slide the cover forward and off.

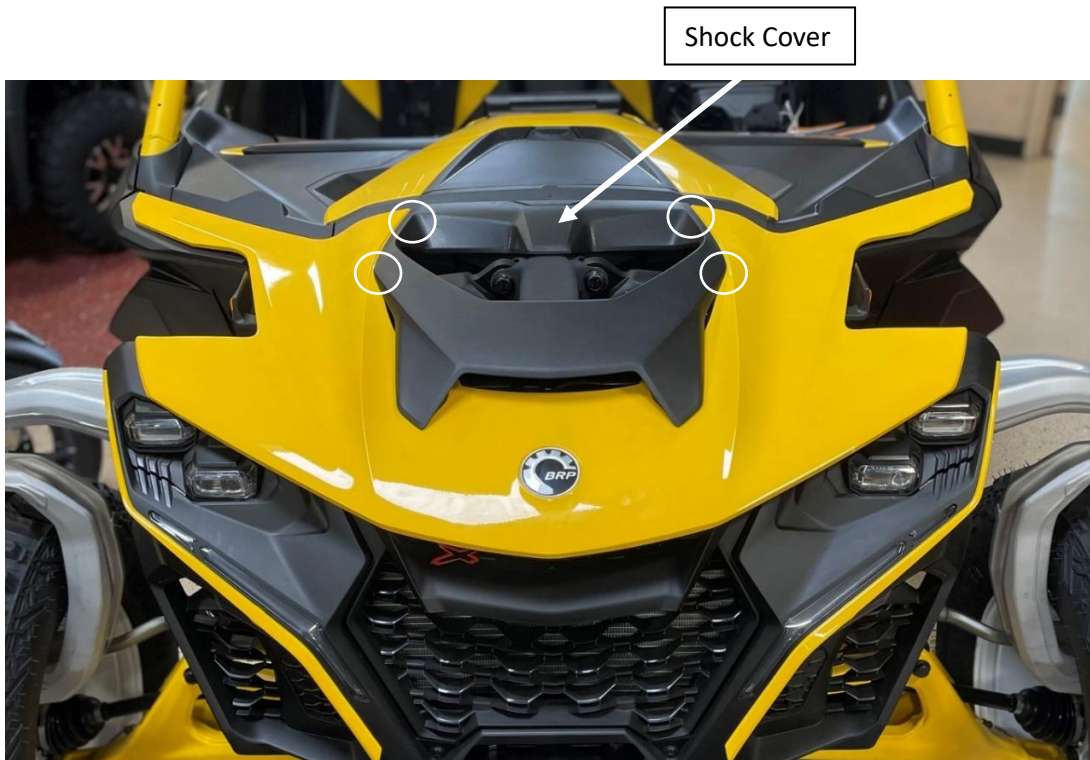

### Step 3: Remove Fuse Box Cover

Remove Fuse Box Cover by pulling up on the latch.

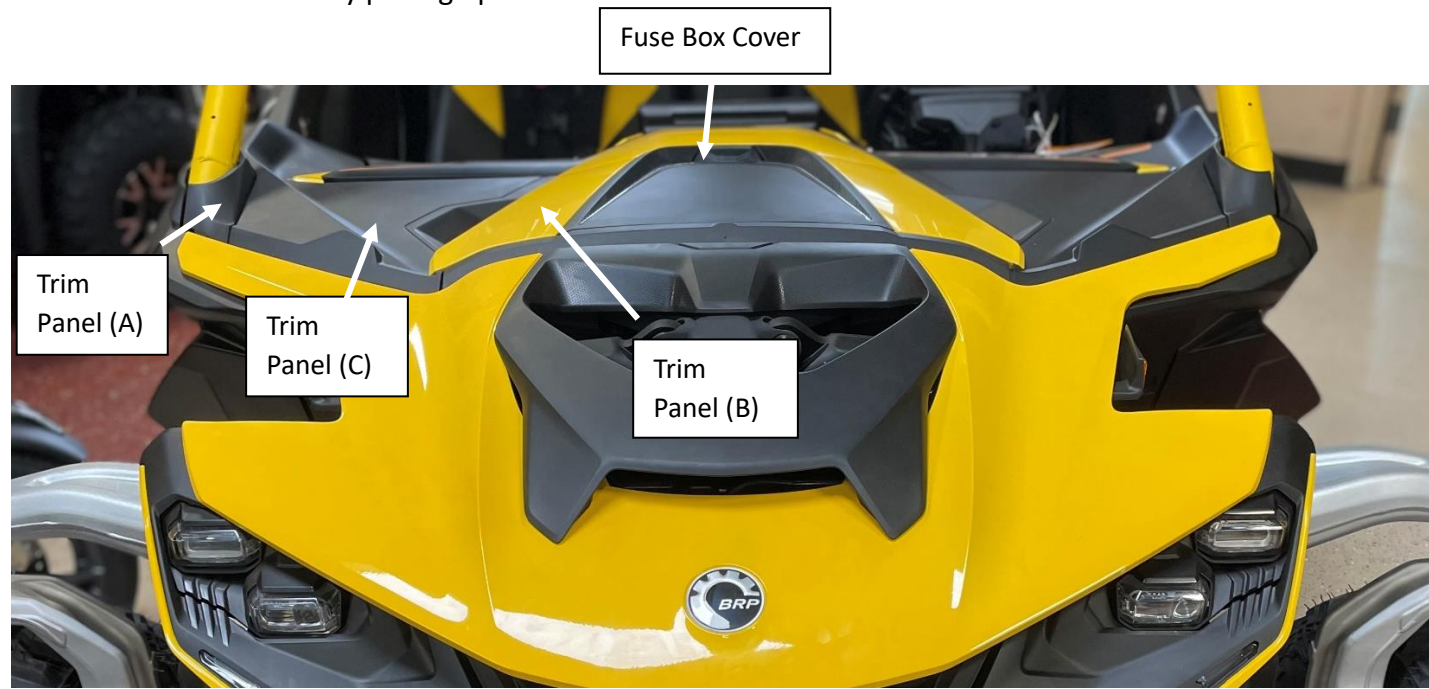

### Step 4: Remove small trim panel (A)

At the base of passenger side A-pillar tube remove the bolt using a T25 Bit or driver.

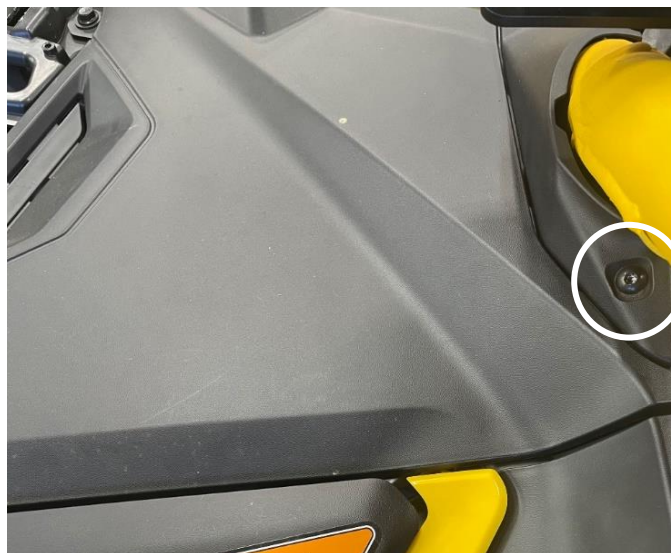

**Step 5: Remove trim panels (B)**

On the passenger side of the open hood remove the panels by pulling straight up firmly. (Clip locations circled)

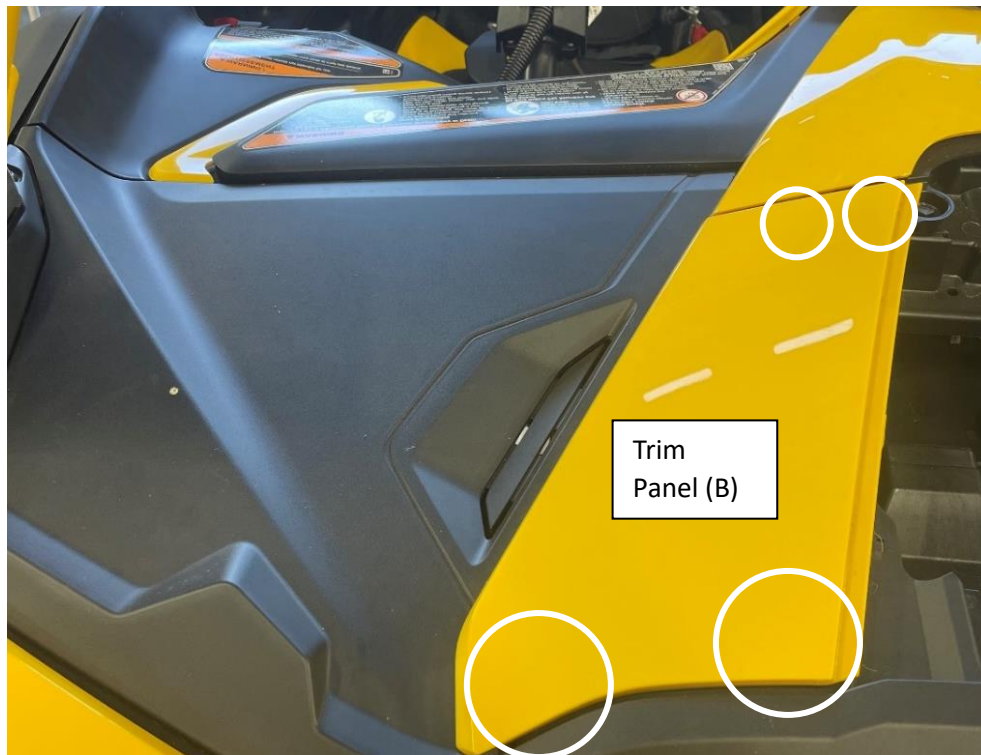

**Step 6: Remove trim panels (C)**

Remove 4X Bolts using a 10mm socket and T27 Bit/Driver. Remove trim panel (C). Passenger side only.

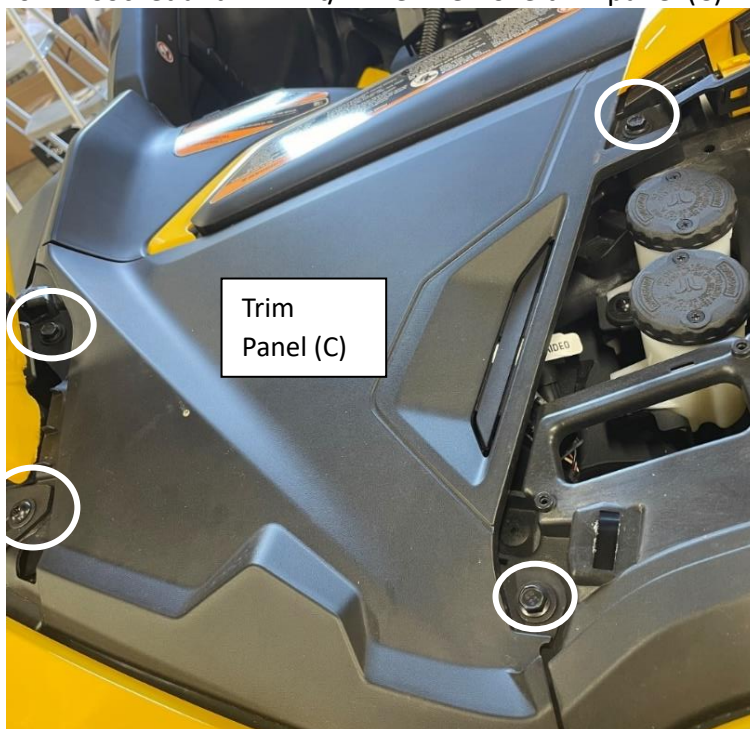

**Step 7: Remove white backing and install EPDM onto brackets.**

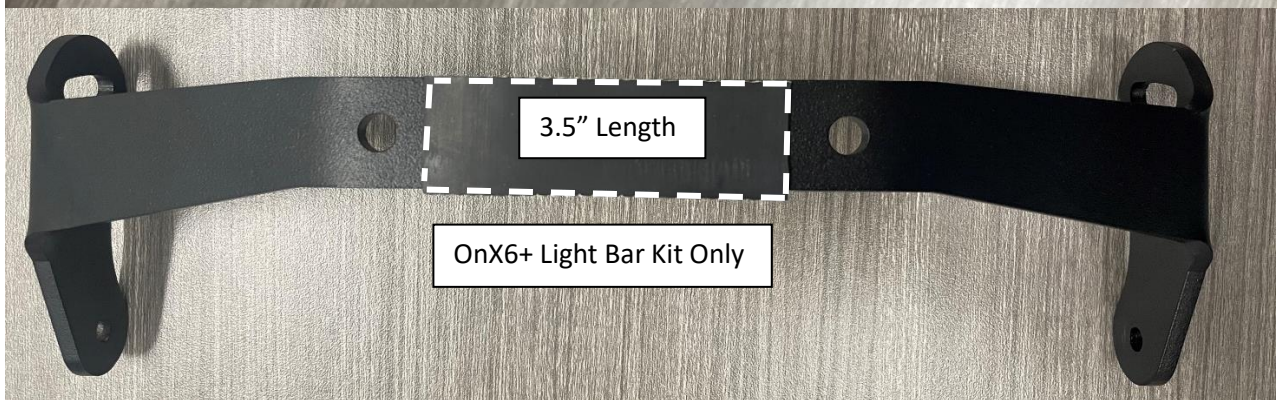
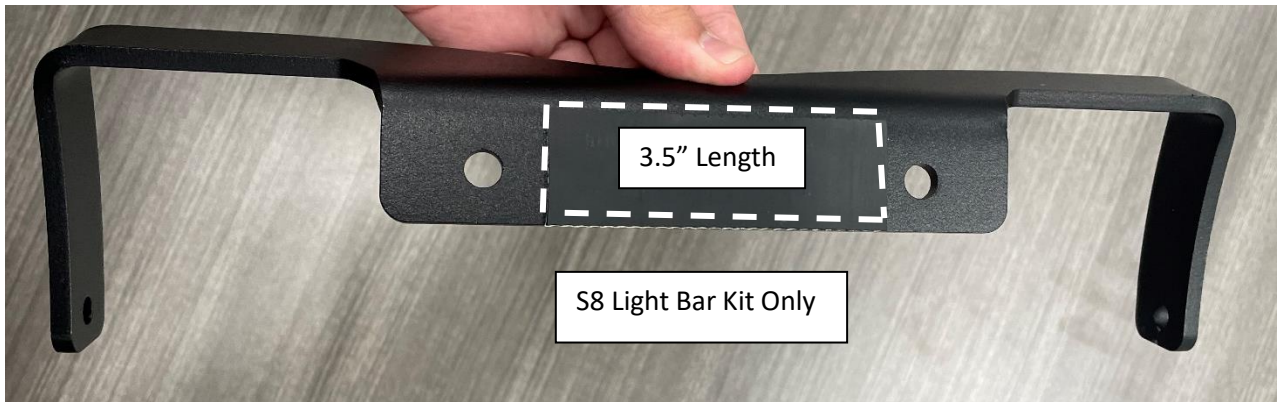
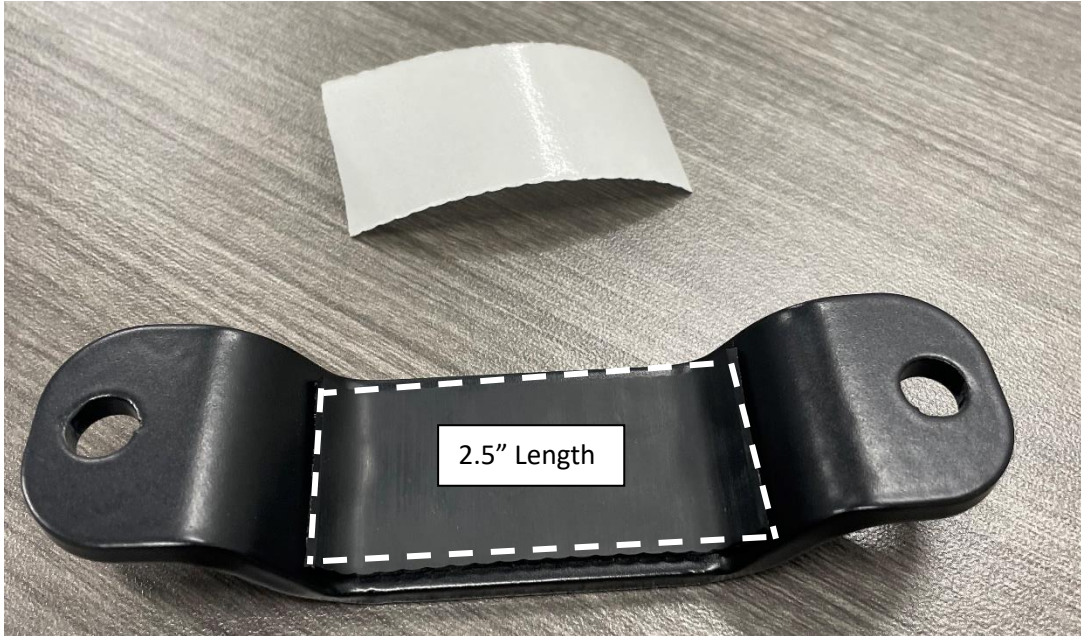

### Step 8: Shock Tower Clamp positioning

Fit the shock tower clamp underneath the frame and position it such that it won't fall.

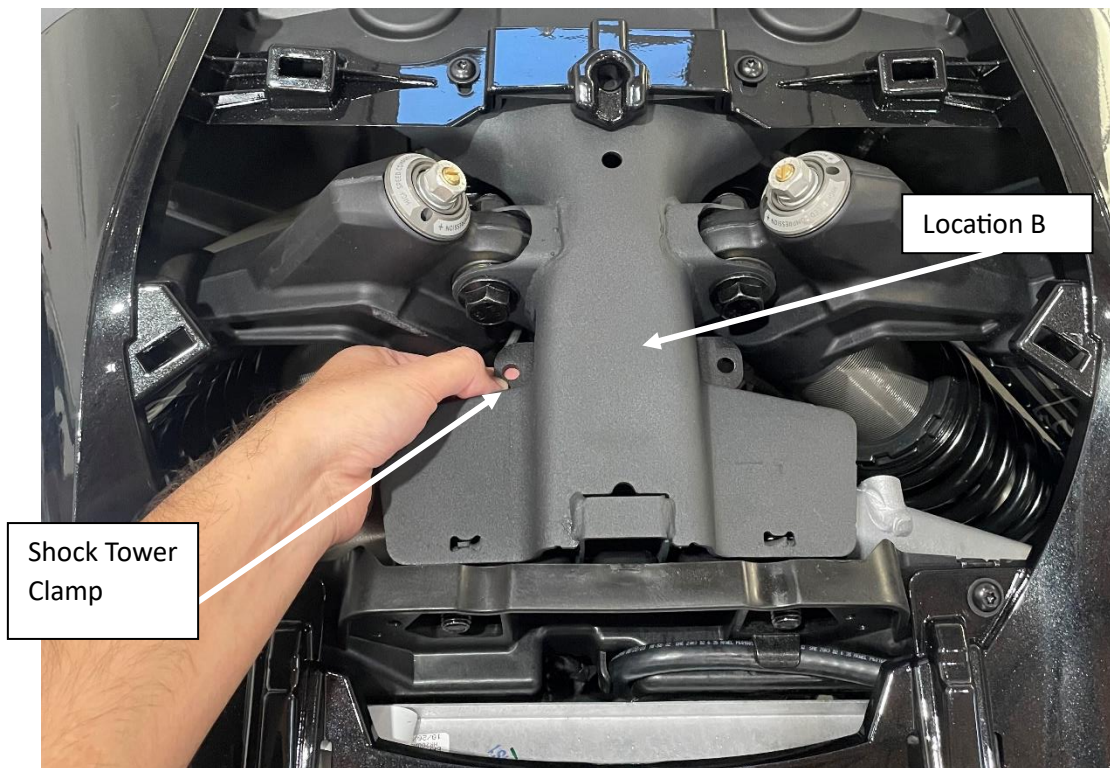

**Note:** Make sure Shock Tower Clamp is orientated such that it is angled towards the front of the vehicle.

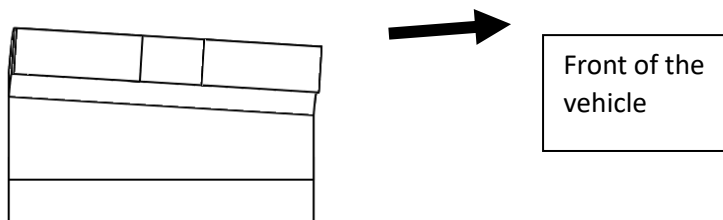

### Step 9: Light Bar Installation

Using a 7/16" Wrench or socket install the light bar onto the light bracket using the hardware provided with the light. Leave loose and angle the light straight down to allow access for two rear mounting bolts.







**Step 10: Bracket installation onto the vehicle**

Using a 13mm wrench on the lower nut and a 13mm deep socket on the bolt head install the light bracket onto the exposed frame at Location B (Step 8). Use one M8X1.25X75mm bolt with the provided spacer, M8 Washer, and Nut. Leave loose.

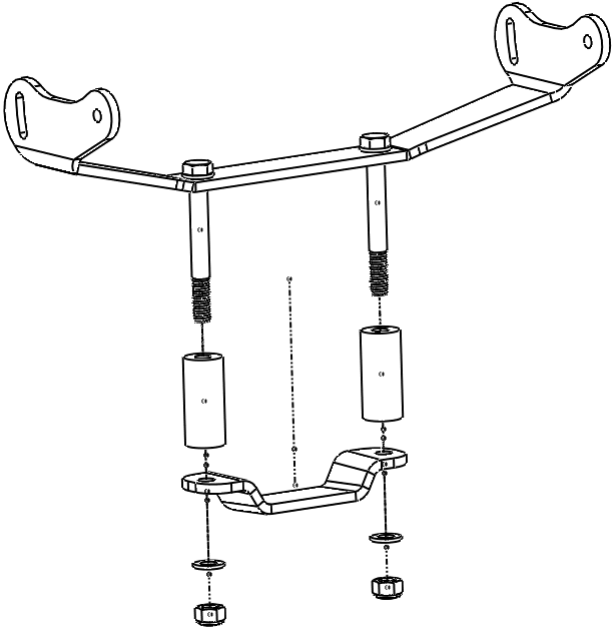

**\*Light removed for improved visibility\***

### Step 11: Additional Hardware installation

Install the second M8X1.25X75mm bolt, spacer, washer, and nut onto the bracket. Go back and forth between the two bolts ensuring you are evenly tightening the bracket.

### Step 12: Secure Wire Harness

Install the U-nut into the bolt hole specified below (F). Use a 7/16" socket to secure the wire harness to U-nut using the provided 3/4-20 X 5/8 Hex bolt and 1/4 Flat washer.

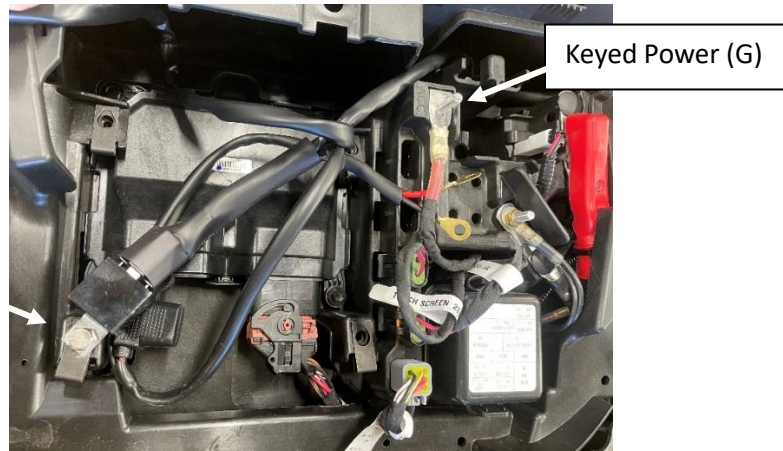

### Step 13: Route harness as shown. DO NOT attach weatherpack connector onto exposed wire harness pins.

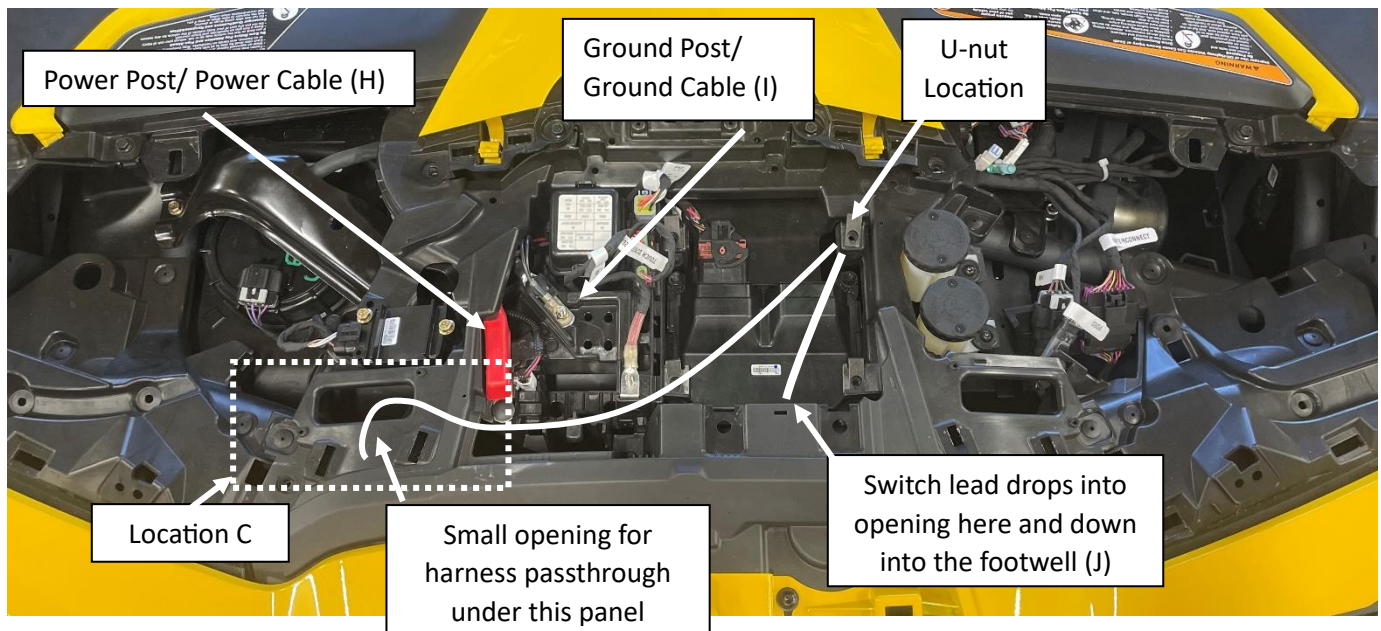

### Step 14: Connector passthrough to the wheel well

Pass the 2-pin lead through the opening specified below.

2-Pin Lead



Location C

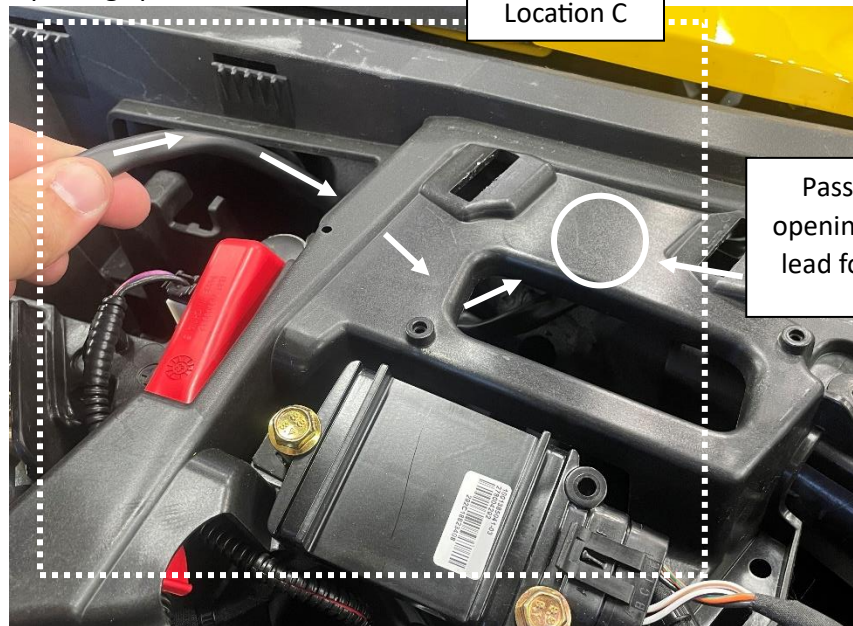

Passthrough opening for 2-pin lead found here

### Step 15: With the connector clear of the narrow passthrough hole install connector onto exposed pins

The connector is labeled with A-B-C

The pinout is as follows:

A- Black/Ground

B- White/ Power

C- Green (S8 Light Bar Only)

**Note: (S8 Only)** If an additional harness was supplied insert the exposed pin into Pin C as seen above. Connect the ring terminal on the additional harness to Keyed power (G) as seen in step 12.

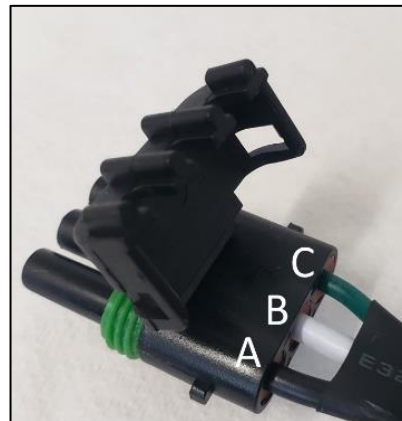

**Step 16: Harness route from wheel well to light bar**

Run the harness through the wheel well down to the tube members and up to the light bar. Connect harness to light bar. Zip tie harness to the tube members and away from suspension/moving/hot components.



Passenger Side Wheel Well

**Step 17: Harness route from footwell to center switch panel**

Run the switch lead through the footwell and under the center dashboard. See Step 13 Location (J) for footwell passthrough opening.

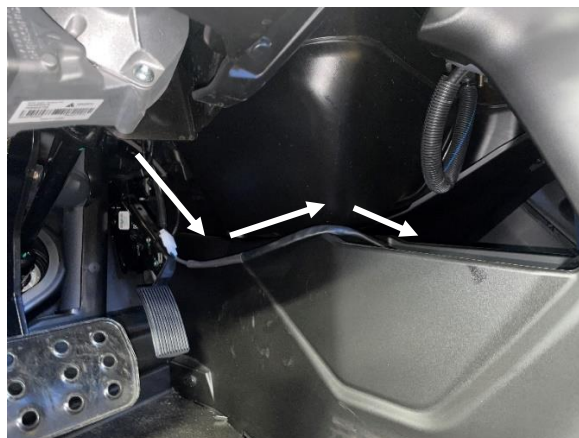

**Step 18: Prep switch panel location**

Remove the center switch panel. By gently pulling it out of the dash panel. Pull the harness out from the exposed opening.



**Step 19: Remove the blank(s) from the switch panel.**

Remove the blanks by squeezing the prong tabs on each side together and pushing the blank out.

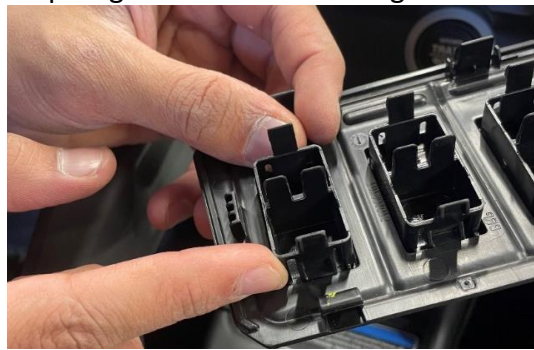

### Step 20: Prep wire harness

Remove the Rocker Switch(s) from Harness and **NOTE THE POSITION OF EACH COLOR CABLE**.

Pull the harness through the switch panel opening and re-connect the switch to the harness.



### Step 21: Install Rocker Switch onto the switch panel.



### Step 22: Clean up

Zip tie all loose cables. Rotate the light back into a forward-facing position and ensure the light is level or facing slightly downward before fully tightening all bolts. Install the ring terminals on the wire harness to the ground post (I) and power post (H) using a 10mm socket. See step 13 for reference.



### Step 23: Reconnect battery cables

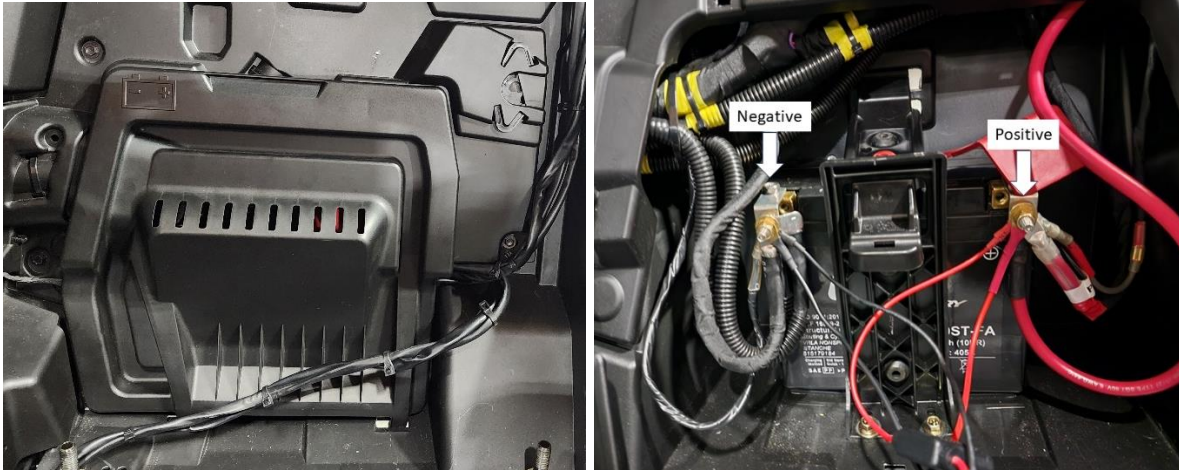

Using a 10mm wrench, reinstall the positive battery cable followed by the negative. Reinstall the battery cover by engaging the top two clips. Test light functionality.

### Step 24: Test functionality

Neatly zip tie all excess harness length and re-install all trim panels.

Note: Be careful when installing the shock cover. The cover will have to be manipulated around the light bar.

### Step 25: Re-install all trim panels

Make sure the harness is secured under the hood/ trim panels.

1. Re-install Trim Panel C (Both sides) Reference step 6
2. Re-install Trim Panel B (Both sides) Reference step 5
3. Re-install Trim Panel A (Both sides) Reference step 4

**Make sure panels are correctly stacked for the best fitment.**

\*Tie all wires away from sharp, hot, and/or rotating components.

\* Re-torque all the fasteners after 100 miles.

\*Your install is now complete! Thank you for choosing Baja Designs.